

FEATURES	
Technology	PIM (Per Inlet Monitoring)
Energy Metering	Voltage(V), Current(A), Active Power(W), Apparent Power (VA), Reactive Power (var), PF, Frequency(Hz), kWh
Metering per Input Line	Yes (Branch Circuit and Total Current) Accuracy 1%
Metering per Output Receptacle	No
Remote Outlet Switching	No
Ethernet Port	2 Gigabit Ethernet ports to access the PDU from 2 different networks
Networking Protocols	DHCP, IPv4 and IPv6, DNS, http / https, SSHv.2, SNMP v1 / v2c / v3, SNMP TRAPS / SETS / GETS, SMTP, Modbus , Telnet, TCP, RADIUS, Syslog, TLS 1.2, SNTP, ARP, ICMP, ICMPv6, UDP, NDP
PDU Cascading	16 PDUs
Power Share	Yes
Network Controller	Replaceable Hot Swapable controller with 4 button OLED display
Residual Current Monitoring	No (optional)
Rack Acces Control	Compatible with DCIM solutions
USB Ports	2 USB A ports WiFi networking,webcam,PDU configuration and mobile interface
Environmental Sensors	All in one Temperature and Humidity sensor with 2 digital inputs (for connect air flow, door sensor, water leak, smoke detector and Vibration sensor) plug and play bus allows to connect 8 EMD devices in one PDU
INPUT	
Plug	IEC 60309 1P+N+E 6h 32A 250V SINGLE PHASE
Lead Length	3 meter
Cable Type	H07RN-F3G4.0 mm ²
Max. Input Load	32A
Rated Input Voltage	190-250V Single phase
Frequency	50-60Hz
Power Capacity	7360W
OUTPUT	
Rated Output Voltage	190-250V Single phase
Output Types	12 IEX (C13/C19) combo (Max rate 16A) EN61984+UL498 certified
Overload Protection	(2) 1 Pole Magnetic Hydraulic CB 16A
CHASSIS	
Dimensions (W x D x H)	482.8 x 44 x 160 mm
Color	RAL 9004 black powder coat
Mounting Options	(2) Metal bracket
Required Torque for Mounting Screws	≥2.54N·m (25.9kgf·cm or 22.4 in·lbs)
OPERATING ENVIRONMENT	
Temperature Range	0° to 60° C (30° to 140° F)
Humidity	0 - 95 %
Elevation	0 - 4000 Meters
CONFORMANCE	
IEC 62368-1 (Third Edition)	

VIEW A:

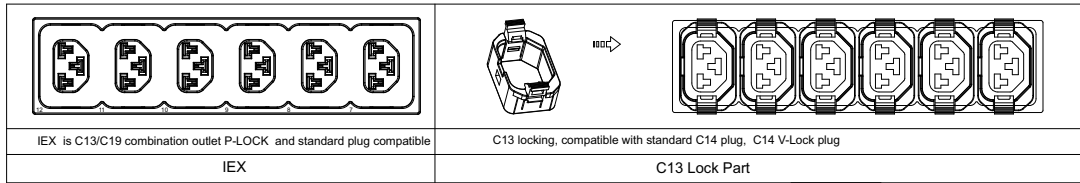

VIEW B:

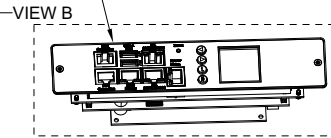
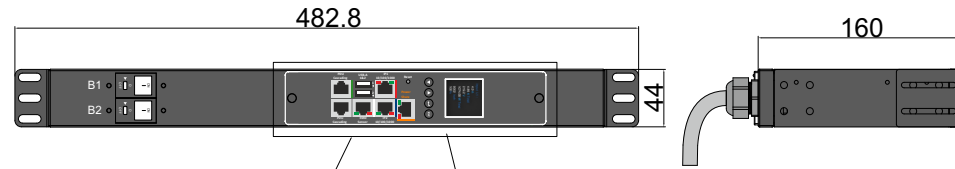
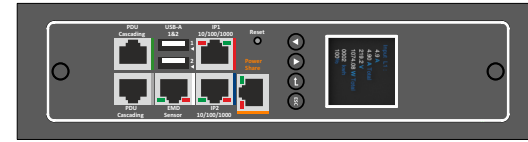

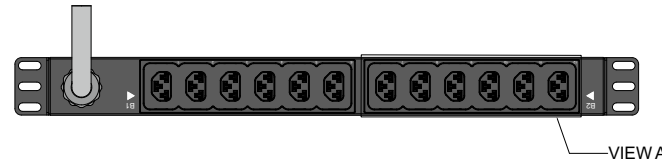
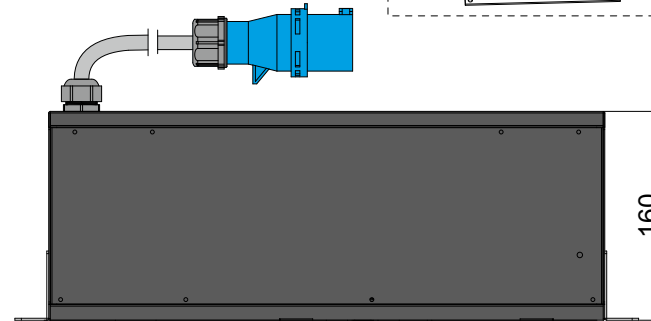

Chassis Color	Code
Black	Standard color
White	W
Red	R
Blue	A
Green	G
Orange	O
Grey	GY
Yellow	Y



Packing content:

IEX Lock-VP  X12 Red

PIM Series Inlet Power Monitoring Environmental Monitoring	OUTPUT (12) IEX (C13/C19) combo Black (Max rate 16A)	OPERATING TEMPERATURE 0° to 60°C	Revisions		
			Rev	Description	Date
INPUT 190-250VAC 32A 50HZ IEC60309 32A 1P+N+E Plug 3m H07RN-F3G4.0mm ² Power Lead	BRANCH CIRCUITS (2) 1 Pole Magnetic Hydraulic CB 16A	MOUNTING ACESORIES (2) Metal bracket			

DRAWING TYPE  (NO PERMISSION.NO CHANGING)		IEXCBPIM601232AH	
unit=mm TECHNICAL STANDARD IT11; NO RUST NO FLAW ON THE SURFACE		Housing	SECC Panel T=1.2mm Black Powder Coating RAL9004
FILLET ANGLE FIRST ANGLE	R0.5 ±0.5°		
		DATE 08-07-2021	

- Low cost locking solution at both ends
- Different colors available
- Patented IEX locking system
- Locking sleeve for C13 and C19 plugs
- VDE, UL approved

IEX PATENTED LOCKING SOCKET - POWER CORD SOLUTION



C14 - C13 Sleeve

H05VV-F3G1 mm²

Color	0,5M	1M	2M
Black	✓	✓	✓
Red	✓	✓	✓
Blue	✓	✓	✓

C14PLOCK - C13 Sleeve

H05VV-F3G1 mm²

Color	0,5M	1M	2M
Black	✓	✓	✓
Red	✓	✓	✓
Blue	✓	✓	✓

C20PLOCK - C19 Sleeve

H05VV-F3G1,5 mm²

Color	1M	2M
Black	✓	✓
Red	✓	✓
Blue	✓	✓



C20PLOCK - C13 Sleeve

H05VV-F3G1 mm²

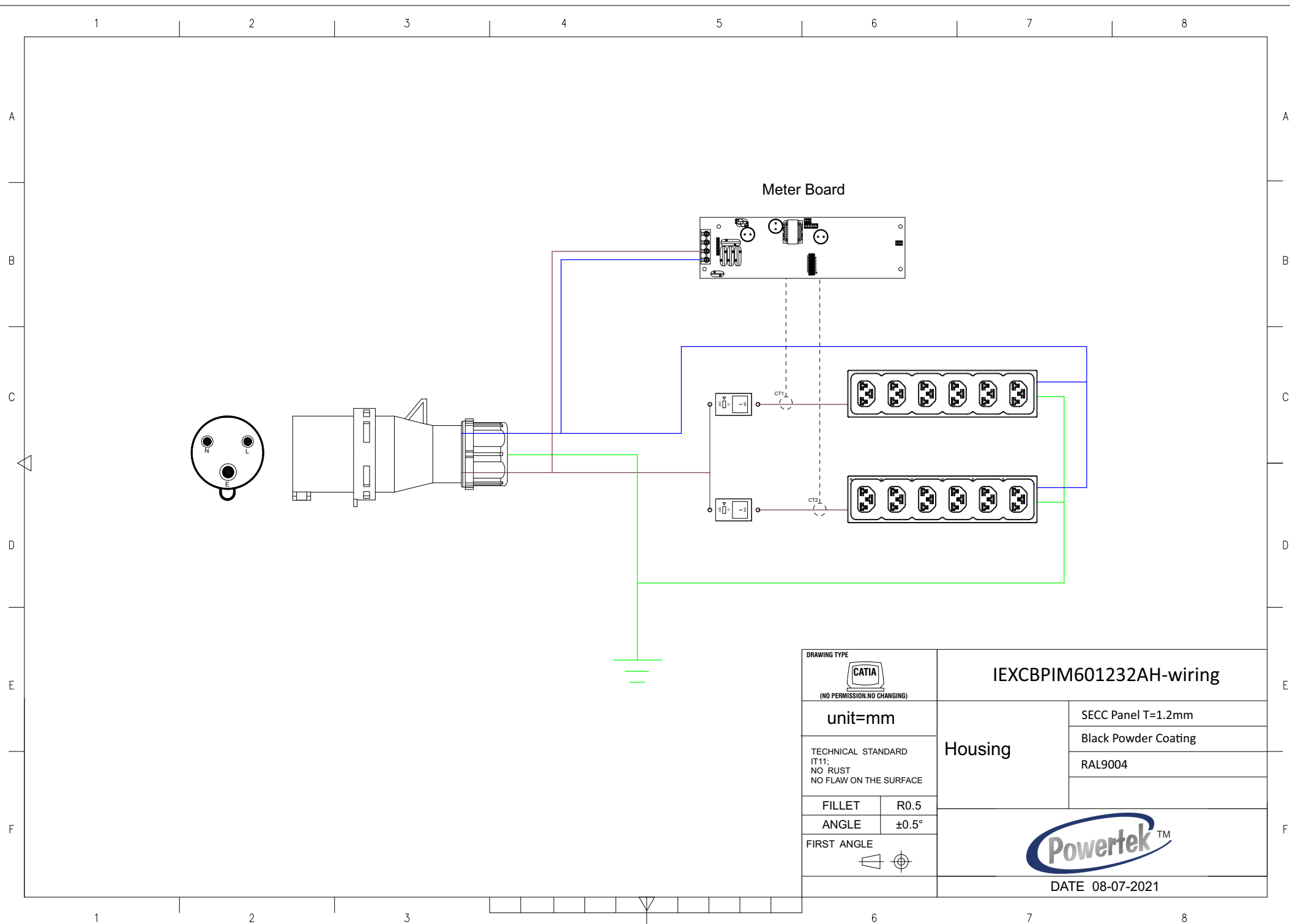
Color	1M	2M
Black	✓	✓
Red	✓	✓
Blue	✓	✓



Meter Board

DRAWING TYPE		IEXCBPIM601232AH-wiring	
 (NO PERMISSION, NO CHANGING)		Housing	SECC Panel T=1.2mm
unit=mm			Black Powder Coating
TECHNICAL STANDARD IT11; NO RUST NO FLAW ON THE SURFACE			RAL9004
FILLET	R0.5		
ANGLE	±0.5°		
FIRST ANGLE			
		DATE 08-07-2021	